

84-806656A5

- 1 - Vapor Separator Tank (VST)
- 2 - Throttle Body
- 3 - Distributor
- 4 - Coil
- 5 - Knock Sensor (KS) Module
- 6 - Data Link Connector (DLC)
- 7 - Manifold Absolute Pressure (MAP) Sensor
- 8 - Knock Sensor
- 9 - Idle Air Control (IAC)
- 10 - Throttle Position (TP) Sensor
- 11 - Engine Coolant Temperature Sensor (ECT)
- 12 - Electronic Control Module (ECM)
- 13 - Fuel Pump Relay (PN 907057)
- 14 - Ignition/System Relay
- 15 - Fuel Pump Fuse
- 16 - ECM/Battery Fuse
- 17 - ECM/Injector Fuse
- 18 - Harness Connector To Starting/Charging Harness
- 19 - Harness Connector To Lanyard Stop Switch (Optional)
- 20 - Harness Connector For Dual Engine Data Link Cable
- 21 - Positive (+) Power Wire To Engine Circuit Breaker

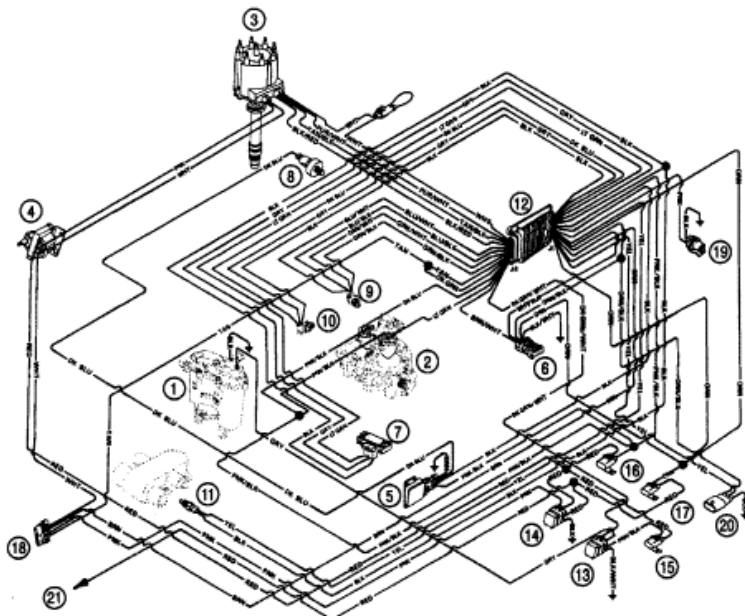

Parts List						
Ref	Class	Part	Description	Qty	Comment	Footnote